

## Welcome to Royal Wagenborg

As experts in international transport by road and water, we offer custom made solutions for every transport need, expertly and with dedication. At Royal Wagenborg the word "impossible" does not exist. We believe that there is a solution for every transport requirement or logistical problem. We offer an integrated approach, including project support, equipment, experienced employees and a global network, reason why our clients have come to increasingly rely on our knowledge and expertise. At Royal Wagenborg safety and reliability are paramount. We are committed to providing you with the highest standard of quality.

## KHAZARBORG, KULANBORG, KAYNARBORG

The shallow draft tugs (SDT) "Khazarborg", "Kulanborg" and "Kyanarborg" were built at Damen Shipyards in Bergum, the Netherlands and delivered to Wagenborg in 1998. The SDTs sail under Kazakh flag in the Caspian Sea.

These SDTs are designed and built for towage services at sea, in shallow water, inland water, harbour and coastal areas.

The vessels can provide assistance during the mooring /unmooring of vessels in ports and alongside offshore installations. They also have a small cargo deck, are fitted with a hydraulic crane for construction activities

and are equipped with a sternroller for anchor handling. An A-frame can optionally be installed.

The navigation and communication equipment of the SDTs exceeds that of similar vessels.

The tugs also have a H2S/gas alarm installed, are equipped with the latest nautical technology, implement a zero dumping policy and meet the highest standards with regard to HSES&Q.

These vessels meet the standards of SOLAS, MARPOL, the Russian Maritime Register of Shipping and Bureau Veritas.

## Wagenborg Offshore

As an international offshore specialist and with many years of experience in the global oil and gas transport business, Wagenborg Offshore has committed professionals at its heart, carrying out complex logistic projects worldwide.

Wagenborg Offshore is a specialist in shallow water transport and has been operating in the Caspian Sea for decades with its dedicated vessels. The company also has vast experience and knowledge of ice navigation in Baltic and Scandinavian waters.

Wagenborg Offshore has state-of-the-art equipment and technologies that comply with the highest quality industry standards.

### GENERAL

Call sign	UNE
Flag	Republic of Kazakhstan
Yard	Damen Shipyards, Bergum Holland
Year	1998
Classification	BV, 3/3 (E) Tug Deep Sea ICE 3. Mach World Wide, Reclassified: Russian Maritime Register of Shipping KM*Ice2 Tug

### DIMENSIONS

Length overall:	24.80 m
Length dwl:	21.10 m
Breadth over all:	09.00 m
Breadth (molded):	08.50 m
Depth:	3.20 m
Draught Max (summer):	2.20 m
Displacement:	254.93
Deadweight:	89 T
Gross Tonnage:	130 GT
Net Tonnage:	39 NT
Bollard Pull:	17 t

### CAPACITIES

Fuel oil :	68.93 m3
Potable water (ballast):	37.41 m3
Sewage:	3.55 m3
Bilge water:	5.76 m3
Dirty oil:	2.06 m3
Lubrication oil:	2.27 m3
Hydraulic oil:	1.14 m3

### ENVIRONMENTAL

Zero dumping provisions  
Intercooling system for machinery

### DECK EQUIPMENT

Towing winch:	Ridderinkhoff BV 600 mtr x 30 mm dia
Pull of towing winch / hook :	392 kN
Breaking load:	635 kN
Capstan ton	A Frame + roller Ridderinkhoff BV 1 x 1
Deck crane	Effer 65000-3SL 4 ton

### SAFETY EQUIPMENT

Lifesaving appliance and Fire-fighting equipment in accordance with SOLAS.

MOB boat/rescue boat:	1 X 6 pers
Life rafts:	2 pcs (10 pers each)
Survival suits:	10 pcs
Inflatable jackets:	8 pcs
Foam jackets:	11 pcs
Lifebuoys:	4 pcs
Fire fighting outfit:	2 pcs
Portable fire extinguisher:	16 pcs

### ELECTRONICS

#### Navigation

Radar Furuno 8 tone daylight display  
Radar Furuno high resolution color display  
Echo sounder Furuno Navigational  
Echo sounder for shallow water  
Sea charts electron and papers

#### Communications

Full GMDSS area A3 installation  
SAT Sailor 150 FleetBroadband

### PROPULSION

Main Engine:	2x 537 kW (Caterpillar C 3412)
Speed:	app. 9.5 kn

### AUXILIARIES

Aux Diesel Generator:	Caterpillar C 4.4 DITA 86 kW 400 V 50 HZ
Harbor Diesel Generator:	Caterpillar C 4.4 DIT 51 kW 400 V 50 HZ

### ACCOMMODATION

Complement:	6 persons
Cabins:	1 single cabin 1 double cabin 1 for 3 persons
Other facilities:	Day-/messroom, wheelhouse and void space.

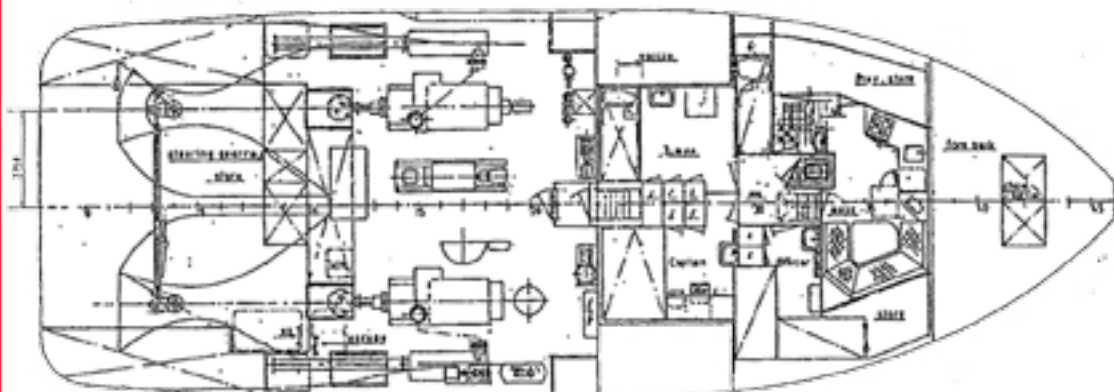
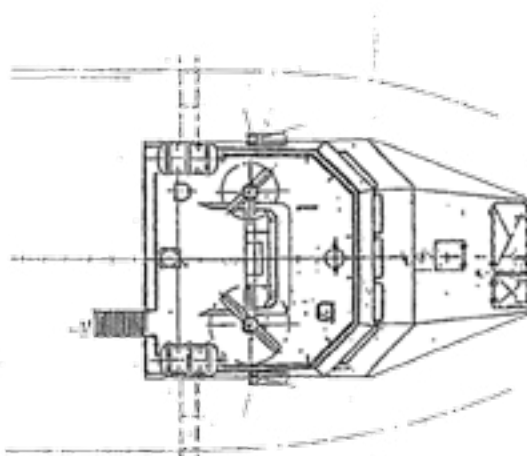

## WAGENBORG OFFSHORE

P.O. Box 14, 9930 AA Delfzijl  
Marktstraat 10, 9934 CK Delfzijl  
The Netherlands  
T +31(0)596 636 911  
F +31(0)596 636 250  
E businessdevelopment@wagenborg.com



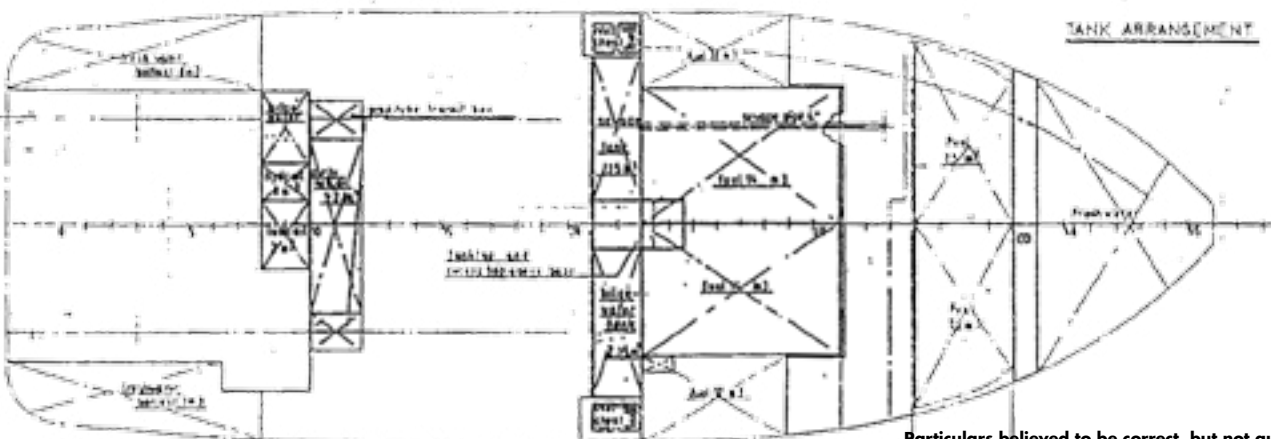
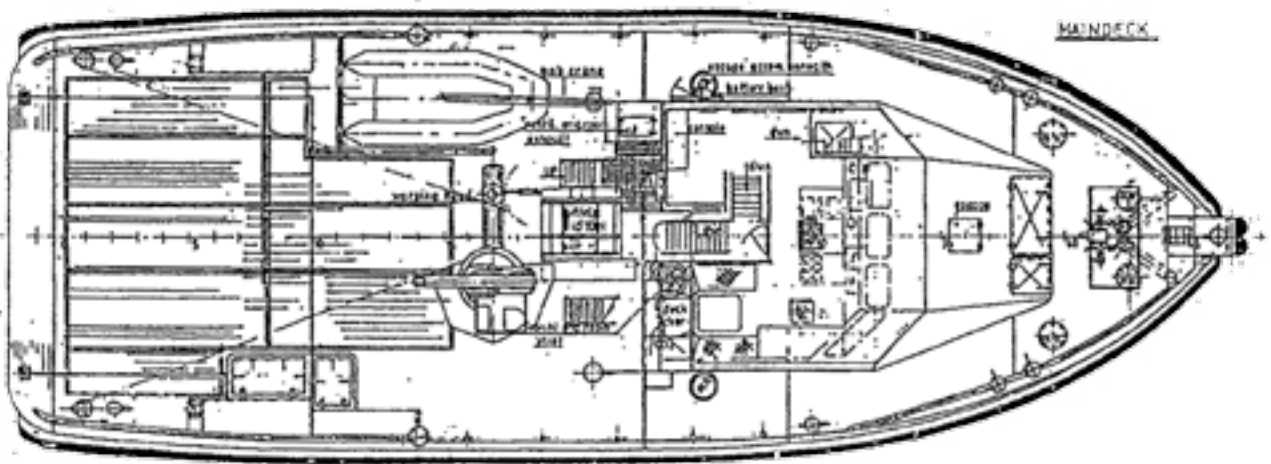
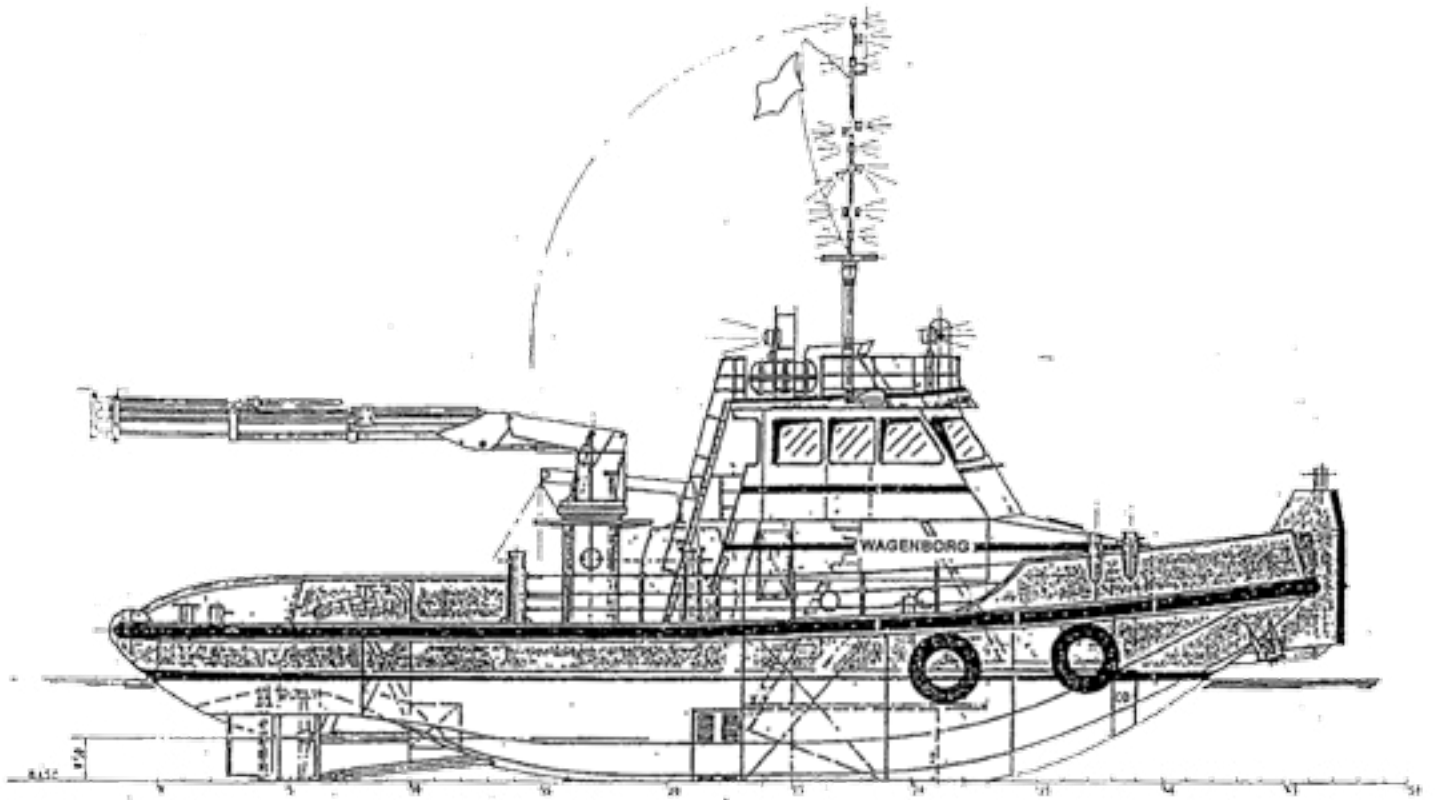

# ANCHOR HANDLING TUG



Particulars believed to be correct, but not guaranteed.

**Head office****ROYAL WAGENBORG**

Marktstraat 10  
P.O. Box 14, 9930 AA Delfzijl, NL  
T +31(0) 596 636 911  
F +31(0) 596 636 250  
E info@wagenborg.com

 [www.facebook.com/royalwagenborg](http://www.facebook.com/royalwagenborg)  
 [www.youtube.com/royalwagenborg](http://www.youtube.com/royalwagenborg)  
 [www.twitter.com/royalwagenborg](http://www.twitter.com/royalwagenborg)  
 [www.linkedin.com/company/wagenborg](http://www.linkedin.com/company/wagenborg)

**Oil & Gas****WAGENBORG OFFSHORE B.V.**

Marktstraat 10  
P.O. Box 14, 9930 AA Delfzijl, NL  
T +31 (0)596 636911  
F +31 (0)596 636250  
E offshore.contracts@wagenborg.com

**WAGENBORG FOXDRILL B.V.**

Kampenstraat 14  
P.O. Box 404, 7570 AK Oldenzaal, NL  
T +31 (0)541 580500  
F +31 (0)541 580505  
E foxdrill@wagenborg.com

**WAGENBORG KAZAKHSTAN B.V.**

Marktstraat 10  
P.O. Box 14, 9930 AA Delfzijl, NL  
T +31 (0)596 636911  
F +31 (0)596 636250  
E offshore@wagenborg.com

**WAGENBORG OILFIELD SERVICES**

629800, Russian Federation  
Yamalo-Nenetskiy autonomous district Noyabrsk  
Promzona, Panel 8  
T +7 3496 354842  
F +7 3496 354852  
E info.russia@wagenborg.com

**WAGENBORG MIDDLE EAST**

P.O.Box 37296, Jebel Ali Free Zone (South),  
Near Redington, Dubai, U.A.E.  
T + 971 4 8894797  
F + 971 4 8894798

**Shipping****WAGENBORG SHIPPING B.V.**

Marktstraat 10  
P.O. Box 14, 9930 AA Delfzijl, NL  
T +31(0)596 636 911  
F +31 (0)596 636 250  
E chartering@wagenborg.com

**WAGENBORG FAR EAST REP. OFFICE**

Yuandong building rm. 1703  
1101 Pudong nan road, Shanghai, China  
T +86-13817579651 (mobile)  
E shanghai.info@wagenborg.com

**WAGENBORG SHIPPING SWEDEN AB**

Fosievägen 17  
P.O. Box 8054, SE-200 41 Malmö, Sweden  
T +46 (0)40 93 71 00  
E info.sweden@wagenborg.com

**WAVE SHIPPING, S.L.**

Francisco Santos, 2 2º Izq.  
28028 Madrid  
T +34 917 253763  
F +34 917 254022  
E wave@waveship.com

**WAGENBORG SHIPPING NORTH AMERICA INC.**

500 Place d'Armes, Suite 2310  
Montreal, Quebec, H2Y 2W2, Canada  
T +1 514 2888282  
F +1 514 8422744  
E info@wagenborgna.ca

**WAGENBORG SOUTH EAST ASIA**

15th Floor, A-Place Building, Coral Way  
Central Business Park 1, Island 1A  
Macapagal Avenue, Pasay City, Philippines 1308  
Tel. +63 2 553 6866  
Fax +63 2 828 6897

**WAGENBORG SAINT PETERSBURG**

5 Gapsalskaya street, office 614 St. Petersburg, Russia  
T +7 (812) 714 98 05  
F +7 (812) 714 97 83

**Storage & warehousing****WAGENBORG STEVEDORING B.V.**

Handelskade Oost 21, 9934 AR Delfzijl, NL  
T +31 (0)596 636911  
F +31 (0)596 630417  
E stevedoring@wagenborg.com

**Projects & Logistics****WAGENBORG PROJECTS & LOGISTICS B.V.**

Marktstraat 10  
P.O. Box 14, 9930 AA Delfzijl, NL  
T +31(0)596 636 911  
F +31 (0)596 636 250  
E chartering@wagenborg.com

**WAGENBORG PROJECTS & LOGISTICS B.V.**

Ridderhaven 27, 2984 BT Ridderkerk, NL  
T +31 (0)180 411169  
F +31 (0)180 465351  
E logistic@wagenborg.com

**Heavy lift & transport****WAGENBORG NEDLIFT B.V.**

Gideonweg 5  
P.O. Box 254, 9700 AG Groningen, NL  
T +31 (0)50 368 2800  
F +31 (0)50 368 2849  
E nedlift@wagenborg.com

**WAGENBORG NEDLIFT B.V.**

Diamantstraat 20  
7554 TA Hengelo, NL  
T +31 (0)74 245 4545  
F +31 (0)74 245 4400  
E nedlift@wagenborg.com

**Towage****WAGENBORG TOWAGE B.V.**

Marktstraat 10  
P.O. Box 14, 9930 AA Delfzijl, NL  
T +31(0)596 636 911  
F +31 (0)596 636 250  
E towage@wagenborg.com